

Precautions on installation - Meter

- When installing the meter outdoors, provide shade to prevent exposure to direct sunlight.
- Do not mount the meter with its display surface facing downwards.
- Avoid installing the meter in a very high temperature environment as this will shorten the battery life.
- Provide clearance around the meter pipe section for piping work. Provide clearance (30cm or more between pipe edge and floor) for turning a box wrench, particularly under a meter pipe section which has lower side bolts and nuts that are difficult to tighten.

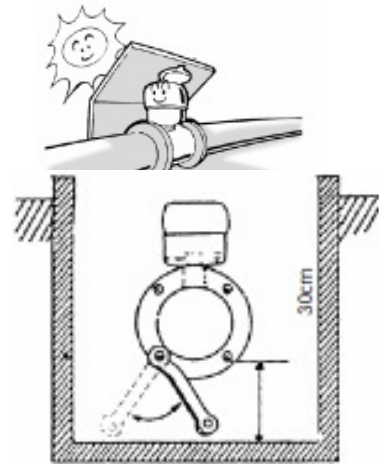

Installation

1. Insert the studding in the lower two bolts and fix the bolts to the flanges.
2. Place the electromagnetic meter on the studs and set it in the desired position, taking care not to subject it
3. Insert the remaining studs and slightly tighten all bolts. Make sure that the meter pipe centre is not displaced and the display is not askew. Fit the gaskets in between the pipe ends and the meter..
4. After you check the displacement of the meter pipe centre, tighten the nuts diagonally in the order shown by the arrows in the figure above. Tighten the nuts to squeeze the gaskets until fully sealed.

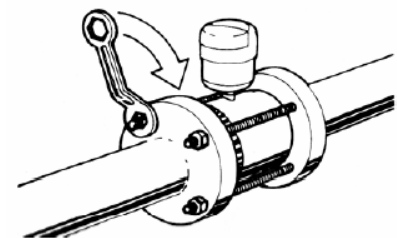
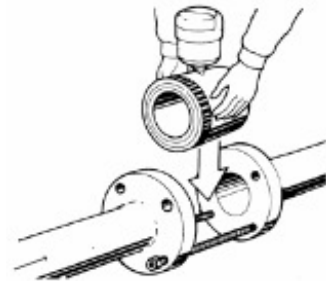
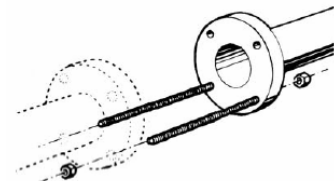

Caution

- Make sure not to step on the display unit of the electromagnetic meter while you are doing the pipework.
- Never try to adjust the meter position using the display unit for grip after tightening the bolts.
- Do not attempt to correct problems by hitting the meter body.

Precautions on piping

- Pipes, especially newly installed ones, often have foreign matter (such as oil) on the inside.
- Be sure to clean the pipe before installing the electromagnetic meter.
- For optimum meter performance, follow the precautions given below and install the meter where it can be easily accessed for maintenance purposes.
- There are no restrictions regarding mounting of the meter on the pipe except the display surface should not be facing downwards.

WARNING: The pipe must always be filled completely with the flowing fluid.

The pipe fluid outlet must be at a higher level than the portion of pipe where the meter is installed.



A leakage at the check valve will allow air into the pipe when the pump stops and will prevent the pipe from being completely filled.

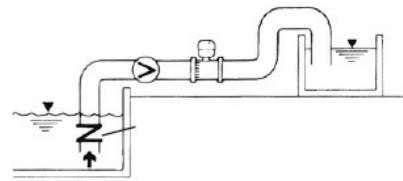

When installing the meter on vertical piping, make sure to mount it on a pipe section in which the fluid flows upwards. Before the meter 5 DN, after the meter 2 DN)

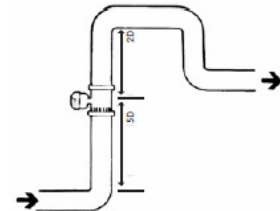

WARNING: No solid substances must be inside the pipe.

Be sure to mount the meter on a vertical section of pipe in which the fluid flows upwards. Also install a shut-off flange for cleaning.

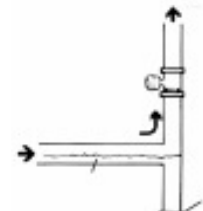

WARNING: A straight section of the pipe is recommended for meter installation.

During fully open position using various valves; the meter can be fixed directly to a gate valve being fully opened.

Applicable to various control valves, such as butterfly and ball valves.

Be sure to install control valves towards the lower end of the downward flow as possible.

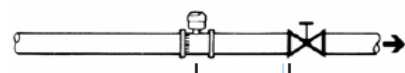
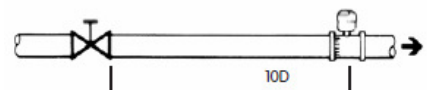
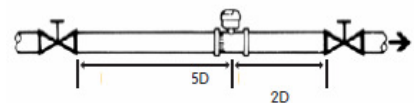

WARNING: No air must be sucked in.

Consider the position of suction mouth..

